

MPS

888.ASK.4.ICC | 888.275.4422

Workstations & Outlets

Premium Products | Proven Performance | Competitive Prices

04

CAT 6A UTP Performance Chart

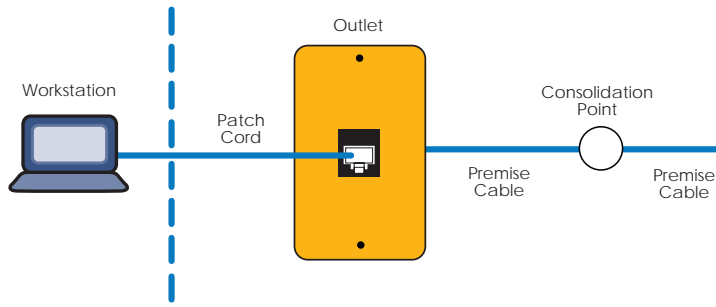
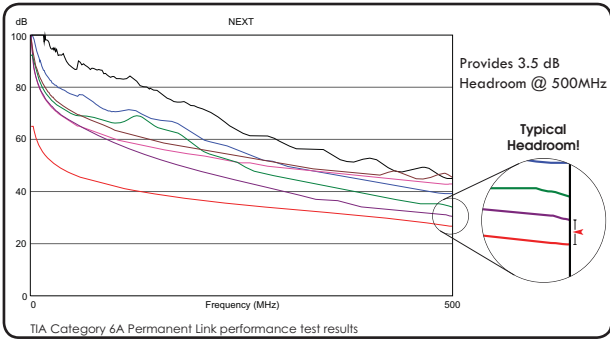

CAT 6^o UTP | CAT 6A 10G High Density (HD) Modular Connectors

Product #	Description	50/400
IC1078GAxx ¹	RJ-45, 8P8C (HD)	

- Exceeds ANSI/TIA-568 Category 6A standard
- Supports 10G data networks
- IDC termination with JackEasy™ tool reduces installation time
- High density design reduces spacing
- Shielded cap reduces Alien Crosstalk (ANEXT)

¹xx= BL-Blue, WH-White



CAT 6A | Compatible Faceplates & Surface Mount Boxes

Product #	Description
A. IC107F0zxx ¹	Classic Single Gang Faceplate
B. IC107LFzxx ¹	Classic Oversized Faceplate
IC107DAzxx ¹	Classic Angled Faceplate
IC107S0zxx ¹	Classic Station ID Faceplate
IC107SFzSS ¹	Classic Stainless Steel Faceplate
c. IC107SBzxx ¹	Classic Surface Mount Box (Recessed for ID Label)
d. IC108SBzxx ¹	Elite Surface Mount Box (Station ID)
ICMPPMB6BK	Mobile Patch Box

¹xx = See pages 15 - 25 for color references

²z denotes port count = See pages 15 - 25 for port count

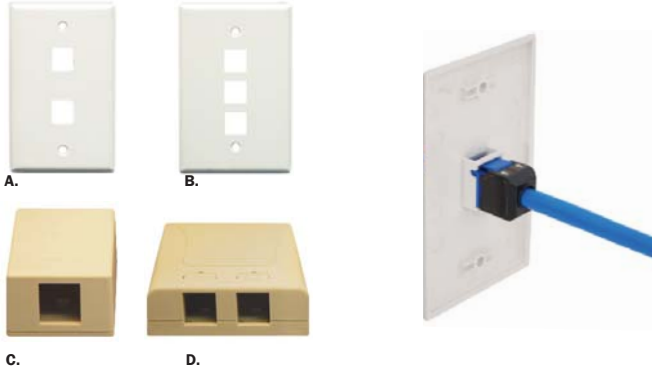

CAT 6^o UTP | Configurable CAT 6A Patch Panel

Product #	Description
IC107PPU6A	UTP, 24-Port Patch Panel, Unloaded, 1 RMS

- Configurable with CAT 6A UTP modular connectors
- Optimized port spacing reduces EMI and unwanted Alien Crosstalk (ANEXT)
- Front write-on labeling area for port identification
- Includes rear cable management bar to facilitate proper cable spacing

1 RMS (Rack Mount Space) = 1.75"

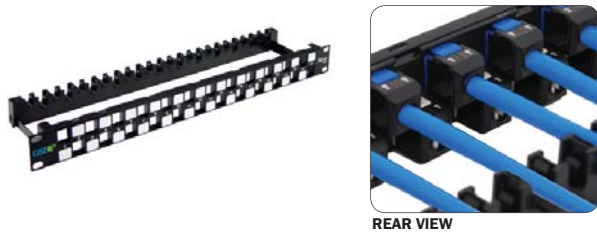

CAT 6^o CAT 6A 650 MHz 10G UTP | Premise Cables

Product #	Description
ICCABP6ABL	4-Pair, 23 AWG, UTP, Solid Copper Cable, CMP, Blue
ICCBP6ABL	4-Pair, 23 AWG, UTP, Solid Copper Cable, CMR, Blue

- Exceeds ANSI/TIA-568 Category 6A standard
- Center separator reduces crosstalk
- Rip cord provides easier jacket removal
- Sequential footage markings on the outer jacket
- Standard Packaging: 1000 feet per reel (305 meters)
- Nominal Velocity of Propagation (NVP) 65% CMR and 67% CMP

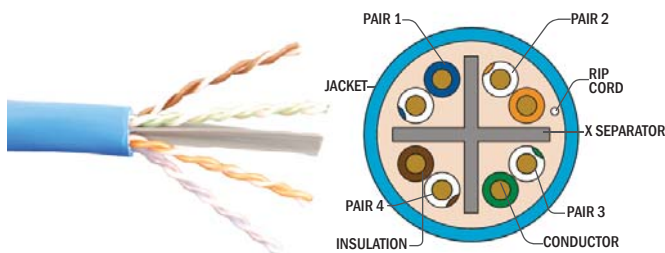

CAT 6A FTP Performance Chart

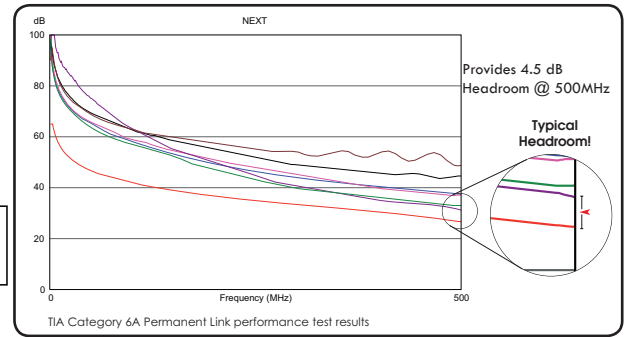
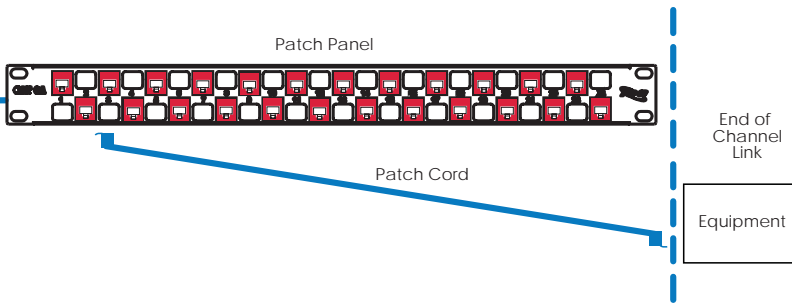

CAT 6^o FTP | CAT 6A 10G Modular Connector

Product #	Description	50/400
IC1078S6A0	RJ-45, 8P8C, Shielded	

- Exceeds ANSI/TIA-568 Category 6A standard
- Supports 10G data networks
- Fully shielded to protect against EMI and Alien Crosstalk (ANEXT)
- Integrated one piece termination cap



See page 67 for Grounding Wire (ICACSGK6AS)

CAT 6A | Compatible Faceplates & Surface Mount Boxes

Product #	Description
IC107F0zxx ¹	Classic Single Gang Faceplate
IC107LFzxx ¹	Classic Oversized Faceplate
A. IC107DAzxx ¹	Classic Angled Faceplate
B. IC107S0zxx ¹	Classic Station ID Faceplate
C. IC107SFzSS ¹	Classic Stainless Steel Faceplate
IC107SBzxx ¹	Classic Surface Mount Box (Recessed for ID Label)
IC108SBzxx ¹	Elite Surface Mount Box (Station ID)
D. IC107PMB6BK	Mobile Patch Box

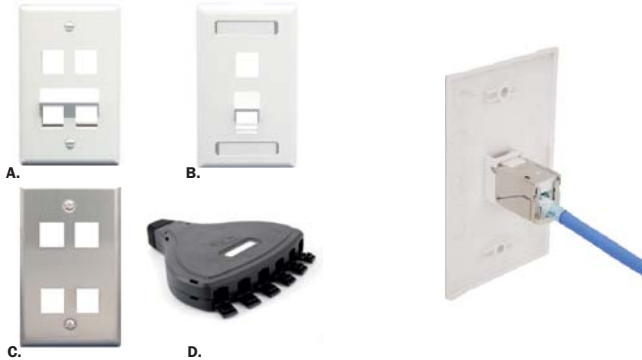

¹xx = See pages 15 - 25 for color references
¹z denotes port count = See pages 15 - 25 for port count

CAT 6^o FTP | Configurable CAT 6A Patch Panel

Product #	Description
IC107PPS6A	FTP, 24-Port Patch Panel, Unloaded, 1 RMS

- Configurable with CAT 6A FTP modular connectors
- Pre-installed with grounding studs for quick and secure installations
- Front write-on labeling area for port identification
- Includes rear cable management bar to facilitate proper bend radius



1 RMS (Rack Mount Space) = 1.75"

CAT 6^o CAT 6A 650 MHz 10G FTP | Premise Cables

Product #	Description
ICCABP6FBL	4-Pair, 23 AWG, FTP, Solid Copper Cable, CMP, Blue
ICCABR6FBL	4-Pair, 23 AWG, FTP, Solid Copper Cable, CMR, Blue

- Exceeds ANSI/TIA-568 Category 6A standard
- Center separator reduces crosstalk
- Shielded jacket provides protection against EMI and RFI noise
- Sequential footage markings on the outer jacket
- Standard Packaging: 1000 feet per reel (305 meters)
- Nominal Velocity of Propagation (NVP) 65% CMR and 70% CMP

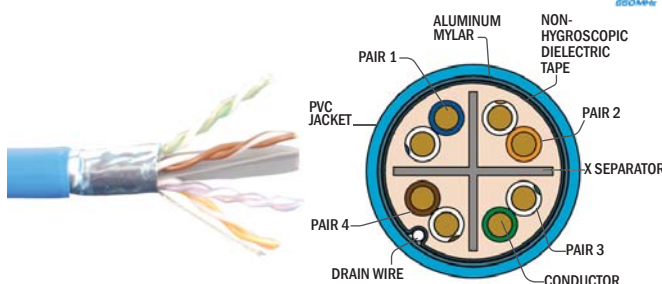

Need CAT 6A patch cords?
Go to page 46

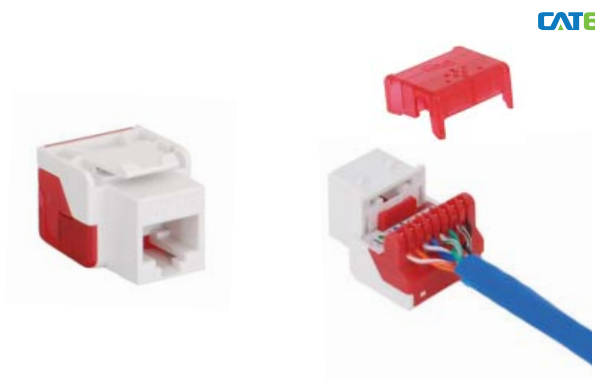

CAT6 EZ (Easy) | CAT 6 Modular Connectors
 Product # *Description* 50/400
IC1078L6xx¹ RJ-45, 8P8C (EZ)

- Exceeds ANSI/TIA-568 Category 6 standard
- Category 6 Component-Rated
- Pair-to-Pair wiring for easy termination and optimal performance

¹xx denotes color = AL-Almond, BK-Black, BL-Blue, GN-Green, GY-Gray, IV-Ivory, OR-Orange, PR-Purple, RD-Red, WH-White, YL-Yellow

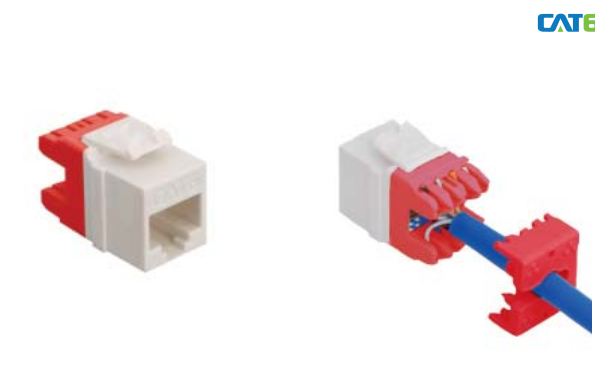

CAT6 HD (High Density) | CAT 6 Modular Connectors
 Product # *Description* 50/400
IC1078F6xx¹ RJ-45, 8P8C (HD)

- Exceeds ANSI/TIA-568 Category 6 standard
- Category 6 Component-Rated
- Split back IDC termination
- Slim body style minimizes spacing between ports

¹xx denotes color = AL-Almond, BK-Black, BL-Blue, GN-Green, GY-Gray, IV-Ivory, OR-Orange, PR-Purple, RD-Red, WH-White, YL-Yellow



CAT6 25 Pack | CAT 6 Modular Connectors
 Product # *Description*
A. IC107L6Cxx¹ RJ-45, 8P8C (EZ) 25 pcs/Pack
B. IC107F6Cxx¹ RJ-45, 8P8C (HD) 25 pcs/Pack

- Category 6 Component-Rated
- Packaged in resealable bags for easy storage
- Reduces packaging waste, environmentally friendly

¹xx denotes color = BK-Black, BL-Blue, IV-Ivory, OR-Orange, RD-Red, WH-White



CAT6 ScTP | CAT 6 Modular Connector
 Product # *Description* 50/400
IC1078S600 RJ-45, 8P8C, Shielded

- Exceeds ANSI/TIA-568 Category 6 standard
- Screen Twisted Pair (ScTP) provides shielding against Electro-Magnetic Interference (EMI)

Why EZ (Easy) Jacks?

Pair-to-Pair, Single Row Terminates in Seconds!

- Fits all Classic and Elite faceplates
- Fits all surface mount boxes
- Fits 16-Port 1 RMS on patch panels



Why HD (High Density) Jacks?

When You Need to Fit More Jacks in a Tight Space.

- Fits all Décorex style faceplates
- Fits all furniture faceplates
- Fits all 24-Port 1 RMS patch panels



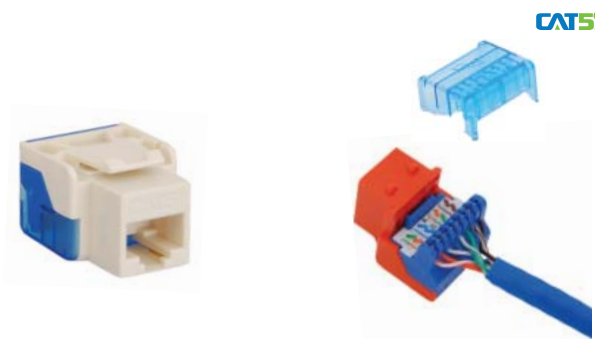

CAT5e EZ (Easy) | CAT 5e Modular Connectors

Product #	Description	50/400
IC1078E5xx ¹	RJ-45, 8P8C (EZ)	

- Exceeds ANSI/TIA-568 Category 5e standard
- Category 5e Component-Rated
- Pair-to-Pair wiring for easy termination and optimum performance

¹xx denotes color = AL-Almond, BK-Black, BL-Blue, GN-Green, GY-Gray, IV-Ivory, OR-Orange, PR-Purple, RD-Red, WH-White, YL-Yellow

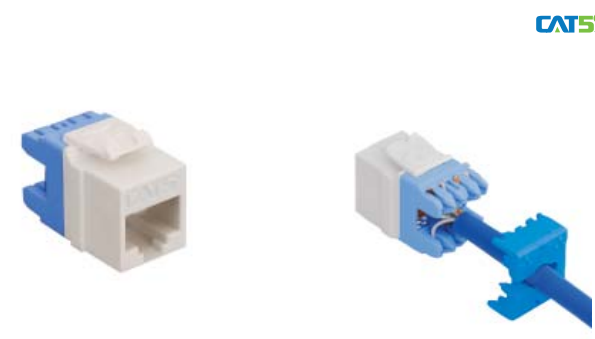

CAT5e HD (High Density) | CAT 5e Modular Connectors

Product #	Description	50/400
IC1078F5xx ¹	RJ-45, 8P8C (HD)	

- Exceeds ANSI/TIA-568 Category 5e standard
- Category 5e Component-Rated
- Split back IDC termination
- Slim body style minimizes spacing between ports

¹xx denotes color = AL-Almond, BK-Black, BL-Blue, GN-Green, GY-Gray, IV-Ivory, OR-Orange, PR-Purple, RD-Red, WH-White, YL-Yellow



CAT5e 25 Pack | CAT 5e Modular Connectors

Product #	Description	25 Pack
A. IC107E5Cxx ¹	RJ-45, 8P8C (EZ) 25 pcs/Pack	
B. IC107F5Cxx ¹	RJ-45, 8P8C (HD) 25 pcs/Pack	

- Category 5e Component-Rated
- Packaged in resealable bags for easy storage
- Reduces packaging waste, environmentally friendly

¹xx denotes color = BK-Black, BL-Blue, IV-Ivory, OR-Orange, RD-Red, WH-White



CAT6 & CAT 5e | Modular Couplers

Product #	Description	50/400
IC107CP6BK	RJ-45, 8P8C, CAT 6	
IC107C5EBK	RJ-45, 8P8C, CAT 5e	

- Exceeds ANSI/TIA-568 Category 6 & CAT 5e standards
- Slim body allows for greater density
- No termination required

color = BK-Black



JackEasy The JackEasy™ tool reduces installation time!
— Termination Tool —

Terminates both HD and EZ modular connectors.

- Terminates and cuts 8 wires simultaneously with a simple squeeze of the handle

Need a JackEasy™ Tool? Go to page 62



EZ (Easy) | CAT 3 Voice Modular Connectors

Product #	Description	50/400
IC1076V0xx ¹	RJ-11, 6P6C (EZ)	

- Designed for voice and CAT 3 data applications
- Pair-to-Pair wiring for easy termination and optimum performance
- Accepts 22-24 AWG solid wire

¹xx denotes color = AL-Almond, BK-Black, BL-Blue, GN-Green, GY-Gray, IV-Ivory, OR-Orange, PR-Purple, RD-Red, WH-White, YL-Yellow

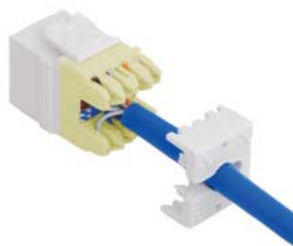

HD (High Density) | CAT 3 Voice Modular Connectors

Product #	Description	50/400
IC1076F0xx ¹	RJ-11, 6P6C (HD)	

- Designed for voice and CAT 3 data applications
- Split back IDC terminations
- Accepts 22-24 AWG solid wire
- Slim body design reduces spacing between ports

¹xx denotes color = AL-Almond, BK-Black, BL-Blue, GN-Green, GY-Gray, IV-Ivory, OR-Orange, PR-Purple, RD-Red, WH-White, YL-Yellow

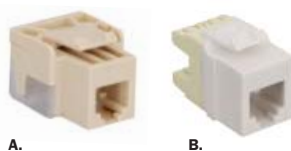

25 Pack | CAT 3 Voice Modular Connectors

Product #	Description	25 Pack
A. IC1076VCxx ¹	RJ-11, 6P6C (EZ) 25 pcs/Pack	
B. IC1076FCxx ¹	RJ-11, 6P6C (HD) 25 pcs/Pack	

- Designed for voice and CAT 3 data applications
- Accepts 22-24 AWG solid wire
- Packaged in resealable bags for easy storage
- Reduces packaging waste, environmentally friendly

¹xx denotes color = IV-Ivory, WH-White



REAR VIEW

CAT 3 | Voice Telephone Couplers

Product #	Description	50/400
IC107C6Sxx ¹	RJ-11, 6P6C, Pin 1-6	
IC107C6Rxx ¹	RJ-11, 6P6C, Pin 1-1	

- Available in RJ-11
- Connect telephone line cords on both ends
- No termination required

¹xx denotes color = BK-Black, GY-Gray, IV-Ivory, WH-White



Voice (EZ) Wiring

Pin.#	USOC	UTP
1	White	White/Green
2	Black	White/Orange
3	Red	Blue
4	Green	White/Blue
5	Yellow	Orange
6	Blue	Green

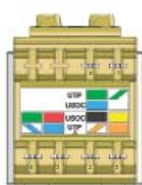

Voice (HD) Wiring

Pin.#	USOC	UTP
6	Blue	Green
1	White	White/Green
4	Green	White/Blue
3	Red	Blue
2	Black	White/Orange
5	Yellow	Orange



Data (EZ) Wiring

Pin.#	TIA 568-A	TIA 568-B
1	White/Green	White/Orange
2	Green	Orange
5	White/Blue	White/Blue
4	Blue	Blue
3	White/Orange	White/Green
6	Orange	Green
7	White/Brown	White/Brown
8	Brown	Brown



Data (HD) Wiring

Pin.#	TIA 568-A	TIA 568-B
8	Brown	Brown
7	White/Brown	White/Brown
6	Orange	Green
3	White/Orange	White/Green
5	White/Blue	White/Blue
4	Blue	Blue
1	White/Green	White/Orange
2	Green	Orange

4 Different Styles to Choose From!

- Accepts RG-6 and RG-59 coaxial cables
- Provides video connectivity for CCTV, CATV, SAT, HDTV applications
- Compatible with ICC faceplates, inserts, surface mount boxes and blank patch panels

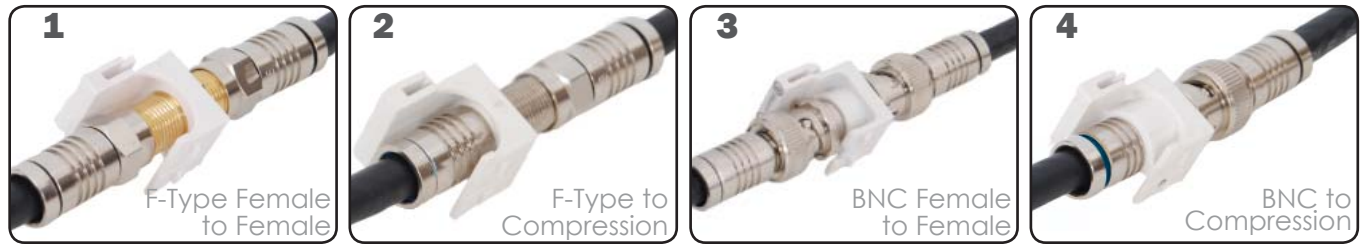

1.



F-Type Video | Modular Connectors

Product #	Description	50/400
IC107B9Gxx ¹	Female-to-Female, Gold Plated, 3GHz	
IC107B9Fxx ¹	Female-to-Female, Nickel Plated, 3GHz	
IC107B5Gxx ²	Female-to-Female, Gold Plated, 2GHz	
IC107B5Fxx ²	Female-to-Female, Nickel Plated, 2GHz	

- Rear threaded F-Type connectors for secure in-wall connections with both RG-6 and RG-59 coaxial cables

IC107BGCWH	Gold Plated, 2GHz, 25 pcs/Pack	25 Pack
IC107BFCWH	Nickel Plated, 2GHz, 25 pcs/Pack	

housing color = WH-White
¹xx denotes housing color = Al-Almond, BK-Black, IV-Ivory, WH-White
²xx denotes housing color = Al-Almond, BK-Black, GY-Gray, IV-Ivory, WH-White

2.



F-Type Compression | Modular Connector

Product #	Description	50/400
IC107FQGWH	F-Type-to-RG-6 Quad With Blue Band	

- Designed for RG-6 quad shield coaxial cables on the rear side to provide high definition video and superior quality audio performance
- Compression connector built right into the module to eliminate one connector and minimize signal loss

See page 67 for Compression Connectors

housing color = WH-White
 Not compatible with plenum cable

3.



BNC Video | Modular Connectors

Product #	Description	50/400
IC107B3Gxx ¹	BNC Female-to-Female, 50 Ohm, Nickel Plated	
IC107BNCxx ²	BNC Female-to-Female, 75 Ohm, Nickel Plated	

- Nickel plated
- Superior signal quality with minimal loss
- Designed for CCTV, NTSC analog video signals, satellite up and down link signals

¹xx denotes housing color = BK-Black, GY-Gray, IV-Ivory, WH-White
²xx denotes housing color = AL-Almond, BK-Black, GY-Gray, IV-Ivory, WH-White

4.



BNC Compression | Modular Connector

Product #	Description	50/400
IC107BQCWH	75 Ohm for RG-6Q Cable	

- Designed for RG-6 quad shield coaxial cables on the rear side to provide high definition video and superior quality audio performance
- Compression connector built right into the module to eliminate one connector and minimize signal loss

See page 67 for Compression Connectors

housing color = WH-White
 Not compatible with plenum cable

2 Different Styles to Choose From!

1



HDMI Modular Connectors

- Perfect for wall mounted LCD/LED/Plasma TVs
- Route cable behind wall for professional aesthetic appearance
- Allows for a fast and easy flush mount faceplate connections
- HDMI female to female feed-through design
- Up to 6 HDMI in one single gang
- Mix with data or other media

2



HDMI Decorex Inserts

- Available in Single or Dual HDMI Décorex Insert with two blank ports or individual keystone snap-in styles
- Manufactured from high quality durable ABS plastic
- Includes mounting hardware and two blank port fillers

888.ASK.4.ICC | 888.275.4422

Workstations & Outlets

Premium Products | Proven Performance | Competitive Prices

10

1.



HDMI | Modular Connectors

Product #	Description	50/400
IC107HDMxx ¹	HDMI Modular Connector	

- Gold plated HDMI connectors
- Small form factor connector allows up to (6) HDMI connections in a single gang faceplate

¹xx denotes color = AL-Almond, BK-Black, IV-Ivory, WH-White

2.



Single HDMI Insert with Two Open Modular Ports | Décorex

Product #	Description	25/200
IC107DH2xx ¹	HDMI With (2) Open Ports	

- Gold plated HDMI connectors
- Includes (2) blank port fillers for unused ports

¹xx denotes color = AL-Almond, BK-Black, IV-Ivory, WH-White



Dual HDMI Insert with Two Open Modular Ports | Décorex

Product #	Description	25/200
IC107DDHxx ¹	(2) HDMI With (2) Open Ports	

- Gold plated HDMI connectors
- Includes (2) blank port fillers for unused ports

¹xx denotes color = AL-Almond, BK-Black, IV-Ivory, WH-White

4 Different Styles to Choose From!

- Supports audio and video applications
- Gold plated for high quality signal preservation



1.



RCA Female-to-Female | Audio/Video Modular Connectors

Product #	Description		50/400
IC107R6Gxx ¹	Red Insert	IC107B6Gxx ¹	White Insert
IC107G6Gxx ¹	Green Insert	IC107Y6Gxx ¹	Yellow Insert
IC107L6Gxx ¹	Blue Insert	IC107K6Gxx ¹	Black Insert

- Supports audio and video applications
- Colored insulators for easy identification

IC107RR5xx¹ Gold, (2-RD, 1-GN, 1-BL, 1-WH) Component Pack

¹xx denotes housing color = AL-Almond, BK-Black, IV-Ivory, WH-White

2.



RCA Female to F-Type | Audio/Video Modular Connectors

Product #	Description		50/400
IC107RFGxx ¹	Red Insert	IC107BFGxx ¹	White Insert
IC107GFGxx ¹	Green Insert	IC107YFGxx ¹	Yellow Insert
IC107LFGxx ¹	Blue Insert	IC107KFGxx ¹	Black Insert

- Supports audio and video applications
- Colored insulators for easy identification
- Rear threaded F-Type connectors for RG-6 and RG-59 coaxial cables

IC107RF5xx¹ Gold, (2-RD, 1-GN, 1-BL, 1-WH) Component Pack

¹xx denotes housing color = AL-Almond, BK-Black, IV-Ivory, WH-White

3.



RCA Female to IDC | Audio/Video Modular Connectors

Product #	Description		50/400
IC107R8Gxx ¹	Red Insert	IC107B8Gxx ¹	White Insert
IC107G8Gxx ¹	Green Insert	IC107Y8Gxx ¹	Yellow Insert
IC107L8Gxx ¹	Blue Insert	IC107K8Gxx ¹	Black Insert

- Designed for UTP category cables over 110-Type IDC terminations
- Colored insulators for easy identification
- Run audio and video using 4-Pair UTP cable
- No soldering required

IC107B7GWH Solder Tail, Black Insert (White Housing Color Only)
IC107RD5xx¹ Gold, (2-RD, 1-GN, 1-BL, 1-WH) Component Pack

¹xx denotes housing color = AL-Almond, BK-Black, IV-Ivory, WH-White

4.



RCA Female to Compression | Audio/Video Modular Connectors

Product #	Description		50/400
IC107RQRWH	Red Insert	IC107RQWWH	White Insert
IC107RQGWH	Green Insert	IC107RQYWH	Yellow Insert
IC107RQLWH	Blue Insert	IC107RQKWH	Black Insert

- Designed for RG-6 quad shield coaxial cables on the rear side
- Minimized signal loss for improved performance
- Modular keystone and connector in one single piece

See page 67 for RCA Compression Connectors

housing color = WH-White
Not compatible with plenum cable

4 Different Styles to Choose From!

Install ICC's Audio Speaker Spring Clip for easy installation

- Simple spring design makes it easier to insert speaker wires
- Rear "fast-on" crimp connectors

Install ICC's Dual Audio Speaker for high density applications

- Saves up to 50% space within the faceplate
- Available in two styles; rear push-pins or rear "fast-on" crimp connectors



1
Dual Speaker Spring Clip



2
Dual Front & Rear Push Buttons



3
Gold Binding Post

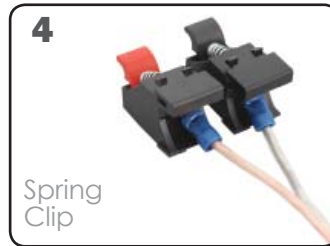

4
Spring Clip

888.ASK.4.ICC | 888.275.4422

Workstations & Outlets

Premium Products | Proven Performance | Competitive Prices

1.



FRONT

REAR

Dual Audio Speaker | Audio Speaker Modular Connectors

Product #	Description	200/800
IC107DSCxx ¹	Dual Speaker Spring Clip With Blade Connector (PATENTED)	

- High density keystone style
- Easy installation with solderless crimp-on rear wire connections
- Black and red push buttons with + and - signs for correct polarity
- Accepts speaker wire up to 16 AWG

¹xx denotes color = AL-Almond, BK-Black, IV-Ivory, WH-White

2.



FRONT

REAR

Dual Audio Speaker | Audio Speaker Modular Connectors

Product #	Description	200/800
IC107DSBxx ¹	Dual Front & Rear Push Buttons (PATENTED)	

- High density keystone style
- Easy installation with push button wire connections
- Black and red push buttons with + and - signs for correct polarity
- Accepts speaker wire up to 16 AWG

¹xx denotes color = IV-Ivory, WH-White

3.



Gold Binding Post | Audio Speaker Modular Connectors

Product #	Description	125/500
IC107PMGxx ¹	Gold Binding Post, 1 -Pair, Red & Black Bands	

- Gold plated for optimum performance
- Binding posts accepts up to 8 AWG multi-stranded audio wire
- Compatible with banana plugs allowing ample current flow to high wattage speakers
- Supplied as a pair with red and black bands for easy polarity identification

¹xx denotes color = AL-Almond, BK-Black, IV-Ivory, WH-White

4.



Spring Clip | Audio Speaker Modular Connector

Product #	Description	100/400
IC107BSSBK	Spring Clip, With Red & Black Push Tabs (PATENTED)	

- Simple spring design that makes it quick and easy to insert speaker wires
- Supplied as a pair with red and black spring clips for easy polarity identification
- Accepts speaker wire up to 12 AWG

color = BK-Black



A-to-A | USB 2.0 Modular Coupler

Product #	Description	50/400
IC107UAAWH	USB Modular Coupler, A-to-A	

- USB female-to-female modular connector
- Simplify the connections between computers and peripheral devices

color = WH-White



TYPE A



TYPE B

A-to-B | USB 2.0 Modular Coupler

Product #	Description	50/400
IC107UABWH	USB Modular Coupler, A-to-B	

- USB female-to-female modular connector
- Simplify the connections between computers and peripheral devices
- Can be mounted with either A or B connector facing out

color = WH-White



A.



B.



VGA | Décorex 2-Port & 4-Port Inserts

Product #	Description	25/200
A. IC107DR2xx ¹	VGA With 2 Open Ports	
B. IC107DR4xx ²	VGA With 4 Open Ports	

- 15-Pin VGA female-to-female connectors
- Multiple port openings for additional connectivity
- Includes blank inserts for unused openings

¹xx denotes color = AL-Almond, BK-Black, IV-Ivory, WH-White
²xx denotes color = IV-Ivory, WH-White



FRONT

A.



REAR



FRONT

B.



REAR

S-Video & 3.5mm Stereo | Modular Connectors

Product #	Description	50/400
A. IC107SVIxx ¹	S-Video Over UTP Termination	

- Designed for 22~24 AWG
- Designed with rear 110-Type IDC termination
- Eliminates the need for soldering on the rear side

B. IC107SAPxx¹ Stereo Jack, 3.5mm Over UTP Termination

- Accepts male plug found on typical stereo headsets
- Engineered with rear push-pins for simple and fast connections to UTP cable or any 22~24 AWG wire
- + and - as well as ground terminals for correct polarity

¹xx denotes color = AL-Almond, BK-Black, IV-Ivory, WH-White



A.



B.



C.

Blank & Cable Feed-through | Inserts

Product #	Description	25/200
A. IC107BN0xx ¹	Blank Fill-in, 10 pcs/Pack	
B. IC107BN2xx ²	Cable Feed-through 10 pcs/Pack	25/200
C. ICACSDCICL	Dust Cover Insert, Clear, 10 pcs/Pack	

- Designed to cover extra ports in faceplates until needed
- Allows cable to pass cleanly through the port opening
- Feed-through opening diameter 0.30 inches
- Compatible with ICC voice, data connectors and patch panels
- Snaps on the opening to prevent dust from entering connector

¹xx denotes color = AL-Almond, BK-Black, GY-Gray, IV-Ivory, WH-White
²xx denotes color = AL-Almond, GY-Gray, IV-Ivory, WH-White

4 Different Styles to Choose From!

- Supports optical applications in bringing fiber to the desktop
- Supports both Multimode and Single-mode
- Supports high speed data transmission and broadband applications
- Compatible with ICC faceplates, inserts, surface mount boxes, and blank patch panels
- No termination required, plug and play installations

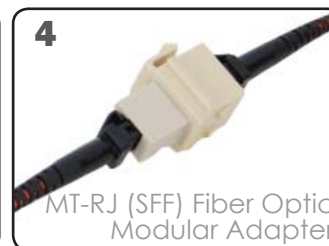
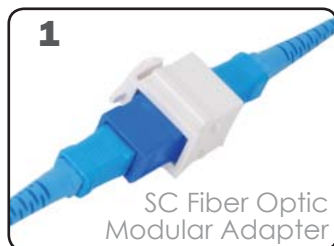

1.



SC Simplex | Fiber Optic Modular Adapters

Product #	Description
IC107SC2xx ¹	SC Modular Adapter, MM/SM (HD)

- Ceramic sleeve for precise multimode and single-mode alignment
- No tools or termination required, plug and play installations
- Adapters snap into ICC faceplates, inserts, surface mount boxes and blank patch panels

¹xx denotes color = IV-Ivory, WH-White

2.



LC (SFF) Duplex | Fiber Optic Modular Adapters

Product #	Description
IC107LC2xx ¹	LC Modular Adapter, MM/SM (HD)

- Ceramic sleeve for precise multimode and single-mode alignment
- No tools or termination required, plug and play installations
- Adapters snap into ICC faceplates, inserts, surface mount boxes and blank patch panels

¹xx denotes color = IV-Ivory, WH-White

3.



ST Simplex | Fiber Optic Modular Adapters

Product #	Description
IC107ST2xx ¹	ST Modular Adapter, MM/SM (HD)

- Ceramic sleeve for precise multimode and single-mode alignment
- No tools or termination required, plug and play installations
- Adapters snap into ICC faceplates, inserts, surface mount boxes and blank patch panels

¹xx denotes color = IV-Ivory, WH-White

4.



MT-RJ (SFF) Duplex | Fiber Optic Modular Adapters

Product #	Description
IC107MRJxx ¹	MT-RJ Modular Adapter (HD)

- Supports both multimode and single-mode transmissions
- No tools or termination required, plug and play installations
- Adapters snap into ICC faceplates, inserts, surface mount boxes and blank patch panels

¹xx denotes color = IV-Ivory, WH-White

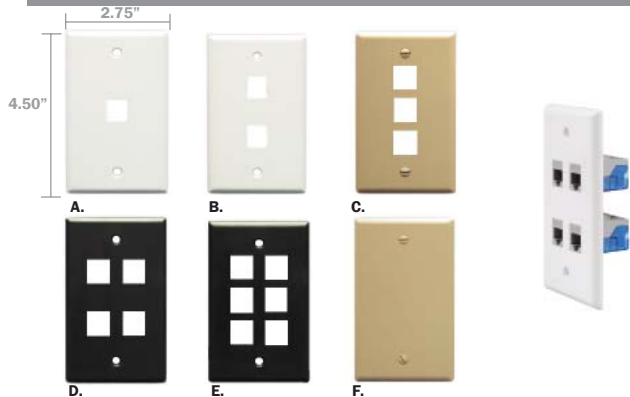

Single Gang | Classic Faceplates

Product #	Description	25/200
A. IC107F01xx ¹	1-Port, Single	d. IC107F04xx ¹ 4-Port, Single
B. IC107F02xx ¹	2-Port, Single	E. IC107F06xx ¹ 6-Port, Single
C. IC107F03xx ¹	3-Port, Single	F. IC630EB0xx ² Blank, Single

- Flush mounting style ideal for commercial and residential applications
- Configured to fit standard single gang outlet box
- ABS plastic for durability

IC107FzCxx³ Single Gang, 25 Pack 

¹xx denotes color = AL-Almond, BK-Black, GY-Gray, IV-Ivory, WH-White
²xx denotes color = AL-Almond, IV-Ivory, WH-White
³xx denotes color = IV-Ivory, WH-White
z denotes port count = 1, 2, 3, 4

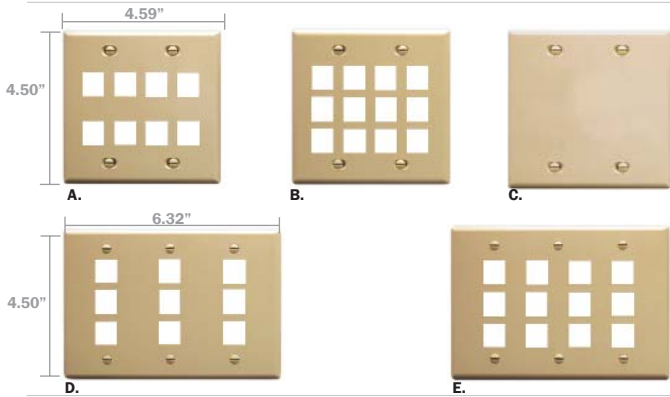

Double & Triple Gang | Classic Faceplates

Product #	Description	25/100
A. IC107FD8xx ¹	8-Port, Double	d. IC107FT9xx ² 9-Port, Triple
B. IC107F12xx ¹	12-Port, Double	E. IC107F10xx ² 12-Port, Triple
C. IC630EBDxx ³	Blank, Double	

- Flush mounting style ideal for commercial and residential applications
- Configured to fit standard double or triple gang outlet box
- ABS plastic for durability

¹xx denotes color = AL-Almond, BK-Black, GY-Gray, IV-Ivory, WH-White
²xx denotes color = GY-Gray, IV-Ivory, WH-White
³xx denotes color = AL-Almond, IV-Ivory, WH-White

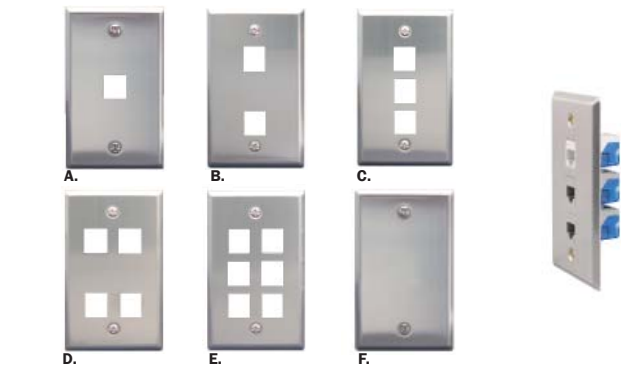

Stainless Steel Single Gang | Classic Faceplates

Product #	Description	25/200
A. IC107SF1SS	1-Port, Single	d. IC107SF4SS 4-Port, Single
B. IC107SF2SS	2-Port, Single	E. IC107SF6SS 6-Port, Single
C. IC107SF3SS	3-Port, Single	F. IC630EBSSS Blank, Single

- Manufactured from 304 stainless steel to provide corrosion resistance
- Configured to fit standard single gang outlet box
- Helps prevent rust and tarnish
- Offers durability and long lasting usage
- Ideal for commercial and industrial applications

Material = STAINLESS STEEL

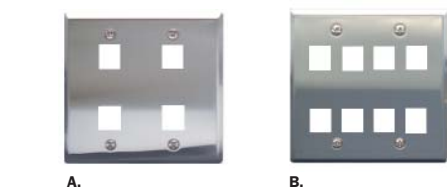

Stainless Steel Double Gang | Classic Faceplates

Product #	Description	25/100
A. IC107DF4SS	4-Port, Double	
B. IC107DF8SS	8-Port, Double	

- Manufactured from 304 stainless steel to provide corrosion resistance
- Configured to fit standard double gang outlet box
- Helps prevent rust and tarnish
- Offers durability and long lasting usage
- Ideal for commercial and industrial applications

Material = STAINLESS STEEL

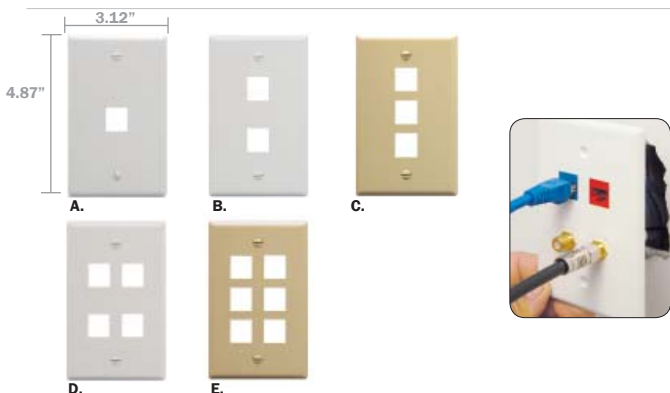

Oversized | Classic Faceplates

Product #	Description	25/200
A. IC107LF1xx ¹	1-Port, Single Gang	
B. IC107LF2xx ¹	2-Port, Single Gang	
C. IC107LF3xx ¹	3-Port, Single Gang	
D. IC107LF4xx ¹	4-Port, Single Gang	
E. IC107LF6xx ¹	6-Port, Single Gang	

- Designed to cover uneven or oversized drywall cuts
- Configured to fit standard single gang outlet boxes
- Height: 4.87" and Width: 3.12"
- ABS plastic for durability

¹xx denotes color = AL-Almond, IV-Ivory, WH-White

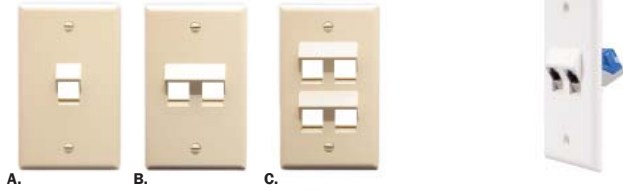

Angled | Classic Faceplates

Product #	Description	25/200
A. IC107DA1xx ¹	1-Port, Angled, Single Gang	
B. IC107DA2xx ¹	2-Port, Angled, Single Gang	
C. IC107DA4xx ¹	4-Port, Angled, Single Gang	

- Configured to fit standard single or double gang outlet box
- Angled faceplate ports reduce cable stress
- ABS plastic for durability

¹xx denotes color = AL-Almond, IV-Ivory, WH-White

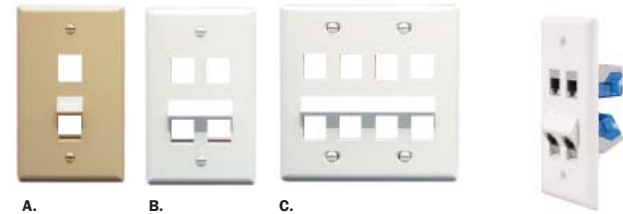

Angled & Flat | Classic Faceplates

Product #	Description	25/200
A. IC107AF2xx ¹	1-Port Flat, 1-Port Angled, Single Gang	
B. IC107AF4xx ¹	2-Port Flat, 2-Port Angled, Single Gang	
C. IC107AF8xx ¹	4-Port Flat, 4-Port Angled, Double Gang	

- Configured to fit standard single or double gang outlet box
- Angled faceplate ports reduce cable stress
- ABS plastic for durability

¹xx denotes color = IV-Ivory, WH-White

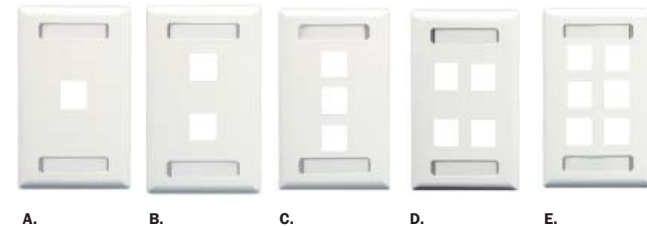

Single Gang | Station ID Classic Faceplates

Product #	Description	25/200
A. IC107S01xx ¹	1-Port, Single Gang	
B. IC107S02xx ¹	2-Port, Single Gang	
C. IC107S03xx ¹	3-Port, Single Gang	
D. IC107S04xx ¹	4-Port, Single Gang	
E. IC107S06xx ¹	6-Port, Single Gang	

- Easy station identification with use of enclosed labels
- Configured to fit standard single or double gang outlet box
- Accepts label dimensions up to 1.70" x 0.40"
- ABS plastic for durability

¹xx denotes color = IV-Ivory, WH-White

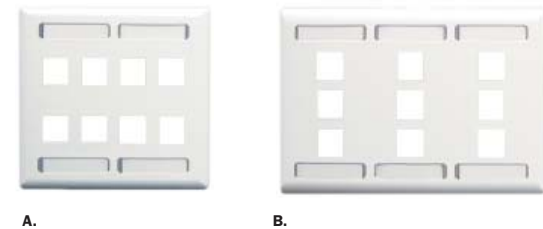

Double & Triple Gang | Station ID Classic Faceplates

Product #	Description	25/100
A. IC107SD8xx ¹	8-Port, Double Gang	
B. IC107ST9xx ¹	9-Port Flat, Triple Gang	

- Easy station identification with use of enclosed labels
- Configured to fit standard single or double gang outlet box
- Accepts label dimensions up to 1.70" x 0.40"
- ABS plastic for durability

¹xx denotes color = IV-Ivory, WH-White

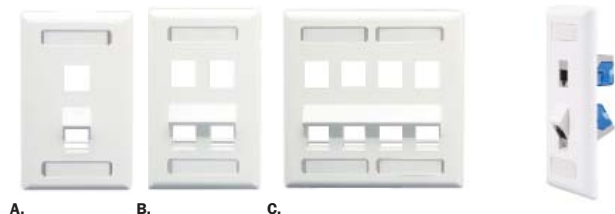

Angled | Station ID Classic Faceplates

Product #	Description	25/200
A. IC107AS2xx ¹	1-Port Flat, 1-Port Angled, Single Gang	
B. IC107AS4xx ¹	2-Port Flat, 2-Port Angled, Single Gang	
C. IC107AS8xx ¹	4-Port Flat, 4-Port Angled, Double Gang	

- Easy station identification with use of enclosed labels
- Configured to fit up to triple gang outlet box
- Angled faceplate ports reduce cable stress
- Accepts label dimensions up to 1.70" x 0.40"
- ABS plastic for durability

¹xx denotes color = IV-Ivory, WH-White

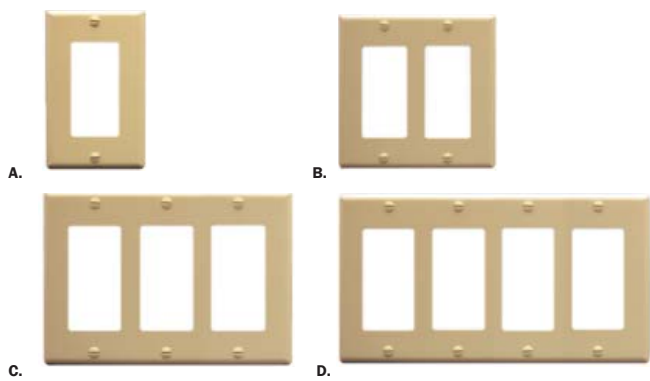

Décorex | Flush Mount Faceplates

Product #	Description	
A. IC107DFSxx ¹	1-Insert, Single Gang	25/200
B. IC107DFDxx ¹	2-Inserts, Double Gang	25/200
C. IC107DFTxx ¹	3-Inserts, Triple Gang	50/200
D. IC107DFQxx ¹	4-Inserts, Quad Gang	25/100

- Designed for a consistent look with standard decor style switches
- Décorex faceplates work with a wide selection of Décorex inserts
- ABS plastic for durability

¹xx denotes color = AL-Almond, BK-Black, IV-Ivory, WH-White

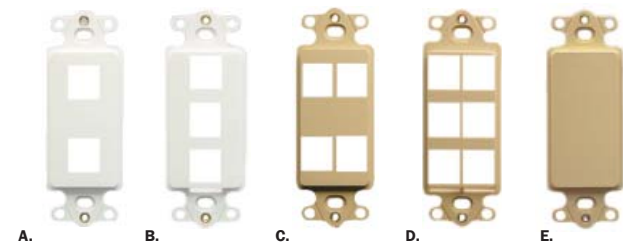

Décorex Inserts | Configurable

Product #	Description	
A. IC107DI2xx ¹	2-Port Insert	50/400
B. IC107DI3xx ¹	3-Port Insert	
C. IC107DI4xx ¹	4-Port Insert (HD)	
D. IC107DI6xx ¹	6-Port Insert (HD)	
E. IC630DIBxx ²	Blank Insert	

- Designed for a consistent look with standard decor style faceplates
- Accommodates a wide variety of easy to snap-in modules
- ABS plastic for durability

¹xx denotes color = AL-Almond, BK-Black, IV-Ivory, WH-White
²xx denotes color = IV-Ivory, WH-White

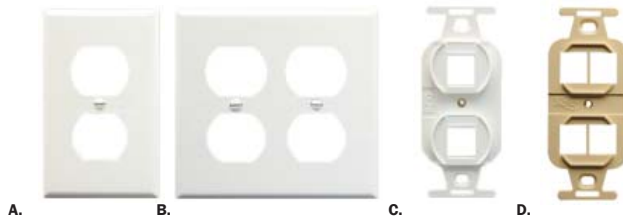

Electrical Faceplates & Inserts | Configurable

Product #	Description
A. IC106FP2xx ¹	2-Port, Single Gang
B. IC106FP4xx ²	4-Port, Double Gang
C. IC107DPIxx ¹	2-Port, Insert, Single Gang
D. IC1074PIxx ¹	4-Port, (HD) Insert

- Configured to fit standard single and double gang outlet box
- Convert electrical faceplates to modular outlets with 2-Port and 4-Port inserts
- ABS plastic for durability

¹xx denotes color = AL-Almond, IV-Ivory, WH-White
²xx denotes color = IV-Ivory, WH-White



Flush | Telephone Wall Plates

Product #	Description
A. IC107FFWSS	1-Port, Single Gang, Stainless Steel
B. IC107FFWxx ¹	1-Port, Single Gang, ABS Plastic

- Flush design provides a clean and smooth surface
- Configured to fit standard single gang outlet box
- Two mounting standoffs for wall mount telephone

¹xx denotes color = AL-Almond, BK-Black, IV-Ivory, WH-White

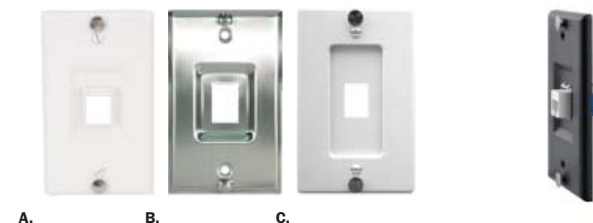

Recessed | Telephone Wall Plates

Product #	Description
A. IC107FRWxx ¹	1-Port, Recessed, ABS Plastic, Single Gang
B. IC107FRWSS	1-Port, Recessed, Stainless Steel, Single Gang
C. IC107FWPxx ²	1-Port, Mounting Standoffs, Single Gang

- Recessed design to accommodate cable
- Configured to fit standard single gang outlet box
- Two mounting standoffs for wall mount telephone
- Use color ID caps for a clean appearance

See page 29 for Color ID Caps (IC107CICxx)

¹xx denotes color = AL-Almond, BK-Black, IV-Ivory, WH-White
²xx denotes color = AL-Almond, IV-Ivory, WH-White

2 Types of Termination

- IDC integrated faceplates allow voice and data signals to be carried over UTP solid cables
- Screw terminated wall plates offer a traditional way of termination
- Wall plates with F-Type connectors provide reliable connections for high quality video



888.ASK.4.ICC | 888.275.4422

Workstations & Outlets

1.

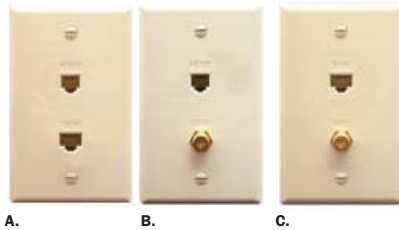

CAT5e CAT 5e Data, Voice, Video | IDC Integrated Faceplates

Product #	Description	30/120
A. ICRDSV05xx ¹	6P6C & CAT 5e	
B. ICRDSVF0xx ¹	6P6C & F-Type	
C. ICRDS0F5xx ¹	CAT 5e & F-Type	

- Rear IDC termination for fast and reliable installations
- Includes IDC caps to secure rear terminated wiring
- ABS plastic for durability

¹xx denotes color = AL-Almond, IV-Ivory, WH-White

1.

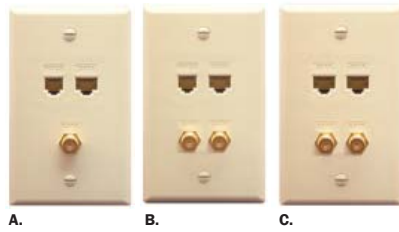

CAT5e CAT 5e Data, Voice, Video | IDC Integrated Faceplates

Product #	Description	25/100
A. ICRDSVF5xx ¹	6P6C, CAT 5e & F-Type	
B. ICRDSV25xx ¹	6P6C, CAT 5e & (2) F-Type	
C. ICRDS2F5xx ¹	(2) CAT 5e & (2) F-Type	

- Rear IDC termination for fast and reliable installations
- Includes IDC caps to secure rear terminated wiring
- ABS plastic for durability

¹xx denotes color = AL-Almond, IV-Ivory, WH-White

2.

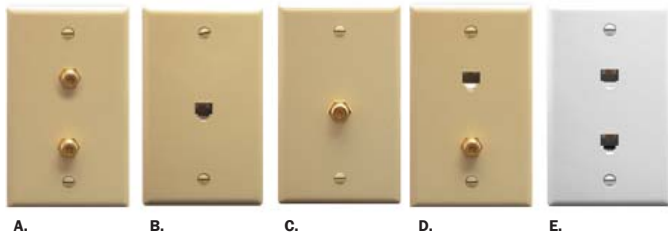

Classic | Screw Terminal Wall Plates

Product #	Description
A. IC630EGGxx ¹	Classic, (2) F-Type
B. IC630E60xx ¹	Classic, 6P6C Rear Screw Terminals
C. IC630EG0xx ¹	Classic, F-Type
D. IC630E6Gxx ¹	Classic, 6P6C Rear Screw Terminals & F-Type
E. IC630E66xx ¹	Classic, (2) 6P6C Rear Screw Terminals

- Voice wall plates are integrated with rear screw down terminals
- No punch down tool required
- ABS plastic for durability

¹xx denotes color = IV-Ivory, WH-White

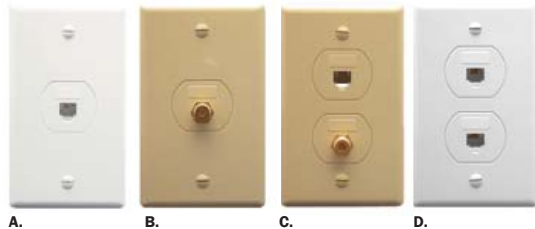

Designer | Screw Terminal Wall Plates

Product #	Description
A. IC630S60xx ¹	Designer, 6P6C Rear Screw Terminals
B. IC630SG0xx ¹	Designer, F-Type
C. IC630S6Gxx ¹	Designer, 6P6C Rear Screw Terminals & F-Type
D. IC630S66xx ¹	Designer, (2) 6P6C Rear Screw Terminals

- Configured to fit standard single gang outlet box
- Provided with traditional screw down terminals or IDC's
- Designed to match electrical faceplates
- ABS plastic for durability

¹xx denotes = IV-Ivory, WH-White

Premium Products | Proven Performance | Competitive Prices



A. B. C.

Integrated Voice & Video | Décorex Inserts

Product #	Description
A. IC630DI6xx ¹	6P6C, Rear Screw Terminals
B. IC630DD6xx ¹	(2) 6P6C, Rear Screw Terminals
C. IC630DVfxx ¹	(1) 6P6C Rear Screw Terminals & (1) F-Type

- Designed for a consistent look with standard decor style faceplates
- Gold plated F-Type connector for CATV and Satellite TV applications
- Provided with traditional screw down terminals for voice connectivity

¹xx denotes color = AL-Almond, IV-Ivory, WH-White

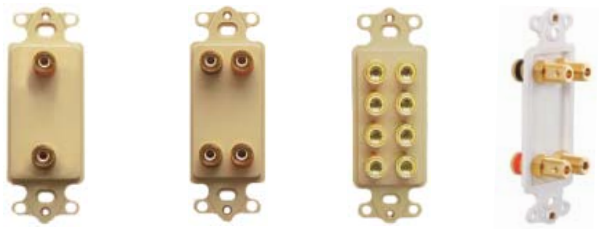

A. B. C.

Integrated Audio Speaker | Décorex Inserts

Product #	Description
A. ICRD55BPxx ¹	2 Gold Binding Posts for Speaker
B. ICRD5DBPxx ²	4 Gold Binding Posts for Speaker
C. ICRD5QBxx ²	8 Gold Binding Posts for Speaker

- Binding posts accepts up to 18 AWG multi-stranded audio wire
- Gold plated for optimum performance
- Binding posts are marked with red and black bands for easy polarity identification

¹xx denotes color = IV-Ivory, WH-White
²xx denotes color = AL-Almond, IV-Ivory, WH-White



A. B. C.

Integrated Voice & Video | Décorex Inserts

Product #	Description
A. IC630DSFxx ¹	F-Type-to-F-Type
B. IC630DDFxx ¹	(2) F-Type-to-F-Type
C. ICRDS3RFxx ²	(3) RCA & (1) F-Type

- Designed for a consistent look with standard decor style faceplates
- Gold plated F-Type connector for CATV and Satellite TV applications
- Provided with traditional screw down terminals for voice connectivity

¹xx denotes color = AL-Almond, IV-Ivory, WH-White
²xx denotes color = IV-Ivory, WH-White



Screw Terminal

Telephone & Video | Screw Terminal Wall Plates

Product #	Description
IC630DB6xx ¹	6P6C, Rear Screw Terminals

- Designed with mounting standoffs for wall mounting telephones
- Configured to fit standard single gang outlet box
- Provided with traditional screw down terminals

¹xx denotes = IV-Ivory, WH-White

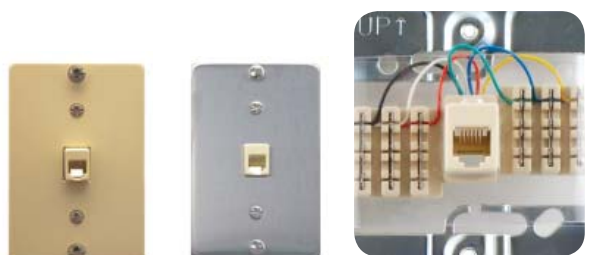

A. B. IDC Terminal

Telephone & Video | IDC Terminal Wall Plates

Product #	Description
A. IC630SS6xx ¹	6P6C, Rear 110-Type IDC Termination
B. IC630DA6SS	6P6C, Rear 110-Type IDC Termination, Stainless Steel

- Designed with mounting standoffs for wall mounting telephones
- Configured to fit standard single gang outlet box
- Provided with IDC terminals

¹xx denotes = IV-Ivory, WH-White



Screw Terminal | Surface Mount Jacks

Product #	Description
IC635DS4xx ¹	RJ-45, 8P4C With Shorting Bar, Keyed
IC635DS8xx ¹	RJ-45, 8P8C With Shorting Bar, Keyed (PICTURED)

- Keyed RJ31X jack with shoring bar allows the alarm and security system to dial out
- Designed with 50 micro inch gold plated screw down terminals
- Multiple mounting options with adhesive backing or screws
- Wiring diagram molded under the cover
- Mount on metallic surfaces with optional magnetic tape
- Pins (1 and 4) & (5 and 8) are connected by shoring bar

¹xx denotes color = IV-Ivory, WH-White



Screw Terminal | Surface Mount Jacks

Product #	Description
A. IC625SB6xx ¹	RJ-11, 6P6C
IC625SB8xx ¹	RJ-45, 8P8C

- Designed with 50 micro inch gold plated screw down terminals
- Multiple mounting options with adhesive backing or screws
- Wiring diagram molded under the cover
- Mount on metallic surfaces with optional magnetic tape

B. IC317MTAPE Magnetic Tape, Adhesive Back, 2 pcs/Pack

- For holding surface mount boxes on metal surfaces

¹xx denotes color = IV-Ivory, WH-White

A.

B.



Bulk Wire | Cover Faceplates

Product #	Description
IC640BSSWH	Single Gang, 0.90"D x 1.25"W Opening
IC640BDSWH	Double Gang, 1.15"D x 2.75"W Opening (PICTURED)

- Configured to fit standard single or double gang outlet box
- ABS plastic for durability

color = WH-White



Configurable | International Faceplates

Product #	Description
IC107EF1WH	1-Port, 86mm x 86mm
IC107EF2WH	2-Port, 86mm x 86mm (PICTURED)

- Designed with spring loaded shutters and covers to prevent dust and particles
- Recessed areas above and below the shutter ports for labels
- Designed to work with international wall outlet dimensions
- Works with ICC voice, data, and fiber optic modular connectors

color = WH-White



Euro Style | Elite™ Multimedia Boxes

Product #	Description
IC108CE1xx ¹	1-Port, Euro Style Mounting Box

- (1) front Elite™ bezel opening
- Complies with European outlet dimensions (83.5 mm x 83.5 mm)
- Station identification
- Works with Elite bezels
- Compatible with ICRW11 and ICRW12 raceway systems

¹xx denotes color = GY-Gray, IV-Ivory, WH-White

Choose From 4 Different Styles!

- Snaps into modular furniture systems including most popular brands such as Herman Miller, Knoll, Hayworth, Steelcase and others
- Compatible with ICC modular connectors

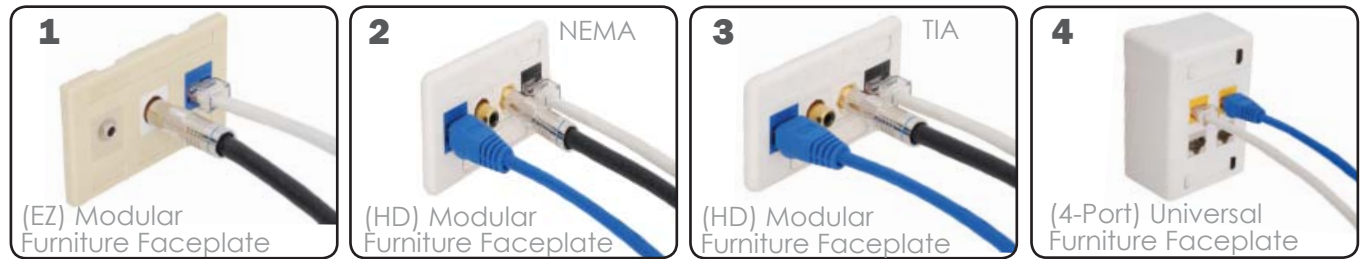

1.

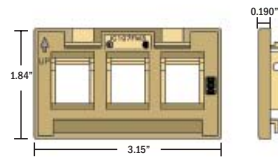

EZ | Configurable Modular Furniture Faceplates

Product # *Description*
IC107FM3xx¹ 3-Port, Furniture Faceplate

- Modern appearance with an easy to use identification scheme
- Fits openings approximately (1.30" x 2.56")
- ABS plastic for durability

¹xx denotes color = BK-Black, GY-Gray, IV-Ivory, WH-White

2.

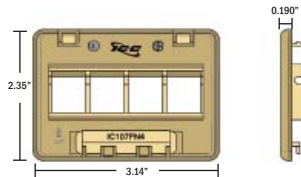

NEMA (HD) | Configurable Modular Furniture Faceplates

Product # *Description*
IC107FN4xx¹ 4-Port, NEMA, Furniture Faceplate

- Designed for high density applications
- Fits openings approximately (1.83" x 2.60")
- Designed with station ID's
- ABS plastic for durability

¹xx denotes color = BK-Black, GY-Gray, IV-Ivory, WH-White

3.

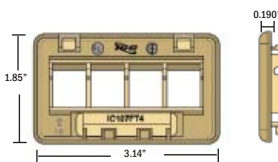

TIA (HD) | Configurable Modular Furniture Faceplates

Product # *Description*
IC107FT4xx¹ 4-Port, TIA, Furniture Faceplate

- Designed for high density applications
- Fits openings approximately (1.33" x 2.60")
- Designed with station ID's
- ABS plastic for durability

¹xx denotes color = BK-Black, GY-Gray, IV-Ivory, WH-White

4.

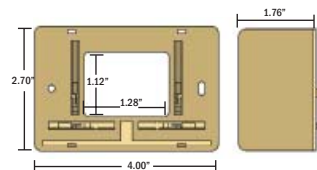

Universal | Configurable Modular Furniture Faceplates

Product # *Description*
IC108UF4xx¹ 4-Port, Universal Furniture Faceplate

- Movable locking tabs adjust to openings from (0.875" x 2.375") to (2.0" x 3.5")
- 2-Piece design (cover and base)
- Designed with station ID's
- ABS plastic for durability

¹xx denotes color = BK-Black, GY-Gray, IV-Ivory, WH-White



Single Gang | Elite™ Multimedia Outlets

Product #	Description
IC108WBSxx ¹	4-Port, Single Gang, Cover & Base

- (2) front and (2) slim Elite™ bezel openings
- Front loading bezels can be custom configured with ICC modular connectors for voice, data, audio, video, and additional fiber optic connectivity
- Easy system administration with use of enclosed icons
- Works with Elite™ and slim bezels

¹xx denotes color = GY-Gray, IV-Ivory, WH-White



Double Gang | Elite™ Multimedia Outlets

Product #	Description
IC108WBDxx ¹	7-Port, Double Gang, Cover & Base

- (4) front and (3) slim Elite™ bezel openings
- Front loading bezels can be custom configured with ICC modular connectors for voice, data, audio, video, and additional fiber optic connectivity
- Easy system administration with use of enclosed icons
- Works with Elite™ and slim bezels

¹xx denotes color = GY-Gray, IV-Ivory, WH-White

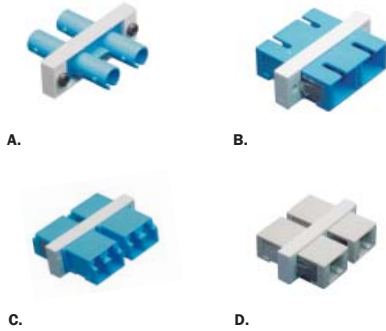

Slim Bezels | Fiber Optic

Product #	Description
A. ICFOBWTBxx ¹	ST/ST, Duplex, Metal Sleeve
B. ICFOBWCBxx ¹	SC/SC, Duplex, Metal Sleeve
C. ICFOBWLbxx ¹	LC/LC, Duplex (SFF), Metal Sleeve
D. ICFOBWMBxx ¹	MT-RJ/MT-RJ, Duplex (SFF)

- Provides (2) or (4) fiber ports per adapter
- Dust caps included
- Compatible with IC108WB multimedia outlets

¹xx denotes color = GY-Gray, IV-Ivory, WH-White



MUTOA | Elite™ Multimedia Boxes

Product #	Description
IC108MMBxx ¹	7-Port, Multimedia Box, Cover & Base

- (1) front and (6) side Elite™ bezel openings
- Rear cable entry
- Compatible with standard NEMA single or double gang electric boxes
- Works with Elite™ bezels
- Compatible with ICRW11, ICRW12, ICRW13 raceway systems

¹xx denotes color = GY-Gray, IV-Ivory, WH-White



Elite™ Faceplates

CUSTOMIZE WITH ICC ELITE FACEPLATES!

ICC's Elite faceplates can be customized with a wide selection of bezels with integrated or configurable connectors.

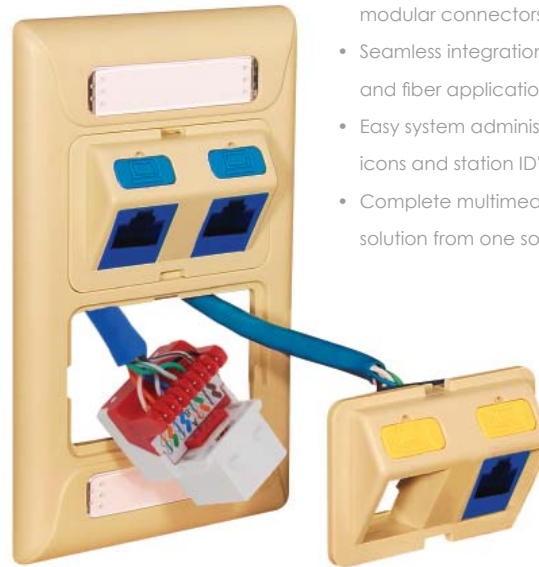
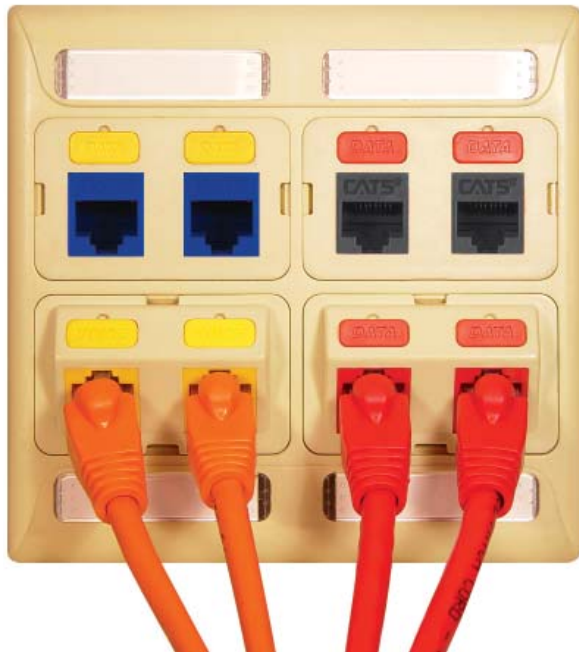

- Cost-effective design to provide ease of installation
- Compatible with ICC Elite Bezels, modular connectors and couplers
- Seamless integration between copper and fiber applications
- Easy system administration with color icons and station ID's
- Complete multimedia wall outlet solution from one source

icc.com | csr@icc.com

Workstations & Outlets



Single & Double Gang | Elite™ Faceplates

Product #	Description
A. IC108F01xx ¹	1-Bezel Opening, Single Gang
B. IC108F02xx ¹	2-Bezel Openings, Single Gang
C. IC108FD4xx ¹	4-Bezel Openings, Double Gang

- Configured to fit standard single or double gang outlet box
- Station ID labels
- Front loading bezel
- Hidden mounting screws
- Works with Elite™ bezels

¹xx denotes color = IV-Ivory, WH-White

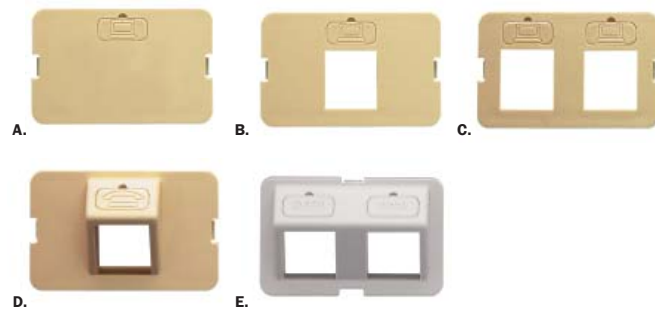

Flat & Angled | Elite™ Bezels

Product #	Description
A. IC108BFBxx ¹	Blank, Flat
B. IC108BF1xx ¹	1-Port, Flat
C. IC108BF2xx ¹	2-Port, Flat
D. IC108BA1xx ¹	1-Port, Angled
E. IC108BA2xx ¹	2-Port, Angled

- Angled design helps cable bend radius
- Icons included, color or special icons available
- Compatible with ICC modular connectors for voice, data, audio, video and fiber connectivity
- Works with Elite™ multimedia boxes and outlets

¹xx denotes color = IV-Ivory, WH-White

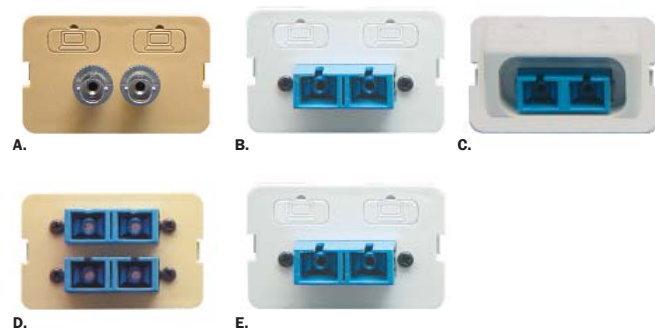

Fiber Optic Multimode | Elite™ Bezels

Product #	Description
A. IC108BFTxx ¹	(2) ST/ST Simplex, Flat
B. IC108BFCxx ¹	SC/SC Duplex, Flat
C. IC108BACxx ¹	SC/SC Duplex, Angled
D. IC108BFDxx ¹	(2) SC/SC Duplex, Flat
E. IC108BFRxx ¹	SC/ST Duplex, Flat

- Provides routing for up to (2) fiber ports
- Works with Elite™ multimedia boxes and outlets
- Metal sleeves

¹xx denotes color = IV-Ivory, WH-White

PremiumProducts | ProvenPerformance | CompetitivePrices

888.ASK.4.ICC | 888.275.4422

Workstations & Outlets

Premium Products | Proven Performance | Competitive Prices



Classic | Configurable Surface Mount Boxes

Product #	Description
IC107SB1xx ¹	1-Port Box
IC107SB2xx ¹	2-Port Box
IC107SB4xx ²	4-Port Box (PICTURED)
IC107SB6xx ²	6-Port Box

- Configurable with ICC modular connectors
- Multiple mounting options with adhesive backings and screws
- Port labeling area for identification

IC107BC1xx ²	1-Port Box, 25 Pack	
IC107BC2xx ²	2-Port Box, 25 Pack	

See page 20 for Magnetic Tape (IC317MTAPE)

¹xx denotes color = GY-Gray, IV-Ivory, WH-White
²xx denotes color = IV-Ivory, WH-White



12-Port | Configurable Surface Mount Boxes

Product #	Description
IC107SBTxx ¹	12-Port Box

- Configurable with ICC modular connectors
- Multiple mounting options including adhesive backings and screws
- ID window and port labeling area for identification
- Used with ICRW11 and ICRW12 raceway systems

See page 66 for Magnet (ICMAGBLOCK)

¹xx denotes color = IV-Ivory, WH-White



Elite | Configurable Surface Mount Boxes

Product #	Description
IC108SB1xx ¹	1-Port Box
IC108SB2xx ¹	2-Port Box
IC108SB4xx ¹	4-Port Box (PICTURED)
IC108SB6xx ¹	6-Port Box

- Configurable with ICC modular connectors
- Multiple mounting options including adhesive backings and screws
- Icons included, color and special icons sold separately
- Used with ICRW11 and ICRW12 raceway systems

See page 66 for Magnet (ICMAGBLOCK)

¹xx denotes color = GY-Gray, IV-Ivory, WH-White

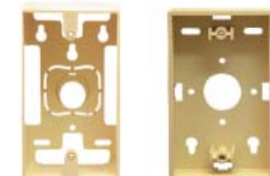

A.

B.

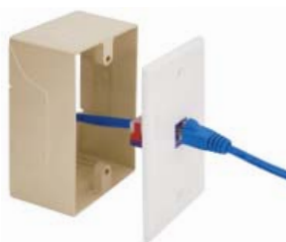

Mounting Boxes

Product #	Description
A. IC107MRSxx ¹	Single Gang (1.89" Depth)
IC107MRDxx ¹	Double Gang (1.89" Depth)

- Compatible with ICC faceplates
- Same size as standard single and double NEMA electrical boxes
- Used with ICRW11, ICRW12, and ICRW13 raceway systems

B. IC250MBSxx ¹	Single Gang, (0.92" Depth)
----------------------------	----------------------------

- Slim design

¹xx denotes color = IV-Ivory, WH-White



Junction Boxes

Product #	Description
ICACSMBSxx ¹	Single Gang, 2-Piece Design (1.89" Depth) (PICTURED)
ICACSMBDxx ¹	Double Gang, 2-Piece Design (1.89" Depth)

- Compatible with ICC faceplates
- Integrated internal routing posts and cable management system
- Rear cable entry for clean external appearance
- Same size as standard single and double NEMA electrical boxes
- Used with ICRW11, ICRW12, and ICRW13 raceway systems

¹xx denotes color = IV-Ivory, WH-White

2 Different Styles to Choose From!

MOBILE PATCH BOXES ARE GREAT FOR USE IN MANY AREAS!

- Warehouses & Industrial Areas
- Trade Shows
- Small Offices
- Classrooms



Configurable | Mobile Patch Box

Product #	Description
IC107MB6BK	6-Port, Unloaded

- Field configurable with IC107 modular connectors
- Multiple mounting options
- Includes dust cover for data port opening
- Designed with station ID's
- Rugged construction for durability

See page 66 for Magnet (ICMAGBLOCK)



CAT 6 | Mobile Patch Box

Product #	Description
ICMPPMB606	6-Port, RJ-45, Loaded

- Exceeds ANSI/TIA-568 Category 6 standard
- PCB module, 110-Type IDC terminations
- Universal T568A and T568B wiring
- Compact design allows for quick and easy installations
- Ideal for: under floor, mobile and multi-user work areas
- Suitable for use with 4-Pair UTP solid cables
- Rugged construction for durability

See page 66 for Magnet (ICMAGBLOCK)



CAT 5e | Mobile Patch Box

Product #	Description
ICMPPMB506	6-Port, RJ-45, Loaded

- Exceeds ANSI/TIA-568 Category 5e standard
- PCB module, 110-Type IDC terminations
- Universal T568A and T568B wiring
- Compact design allows for quick and easy installations
- Ideal for: under floor, mobile and multi-user work areas
- Suitable for use with 4-Pair UTP solid cables
- Rugged construction for durability

See page 66 for Magnet (ICMAGBLOCK)